

XT- 5400AX

11ax 5400Mbps Ceiling Wireless AP

Quick Installation Guide



1/Product introduction

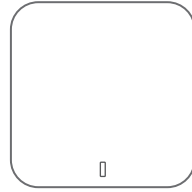

• LED indicator definition

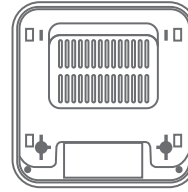

Front



Back

One LED Indicator	Designation	Normal Status	Explanation
	SYSTEM/WIFI LED	Green Light	System boots up successfully
		Blue light	WIFI boots up successfully
Three LED Indicator	Designation	Normal Status	Explanation
	SYSTEM LED	Bright	System boots up successfully
		Flashing	System reset default
	2.4G LED	Flashing	2.4G Wireless boots up successfully
	5.8G LED	Flashing	5.8G Wireless boots up successfully

*The number of LEDs for different models of ceiling mount AP will be different, please refer to the actual product.

• Ports Definition

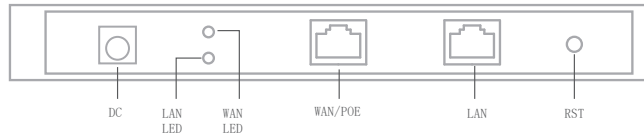

Ports & Buttons	Explanation
DC Socket	Power input port
LED Indicator	LED indicator will bright up when Ethernet cable is connected to WAN/LAN ports
Reset Button	Reset device to factory default settings, press it for 10 seconds when powered on, device will reboot
WAN Port	Connect to internet through ADSL modem or FTTH broadband. Under AP and repeater mode, WAN port will be changed to LAN port
LAN Port	LAN port can connect LAN device

* The interface for different models of products may be different, the above diagram is only for reference, pls refer to the actual product !

• Operation environment



Suitable for safe use in areas below 2000 meters above sea level



Only Suitable for safe use in non-tropical climatic conditions.

2/Device installation

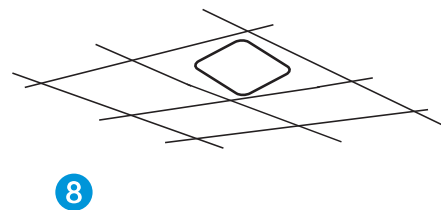
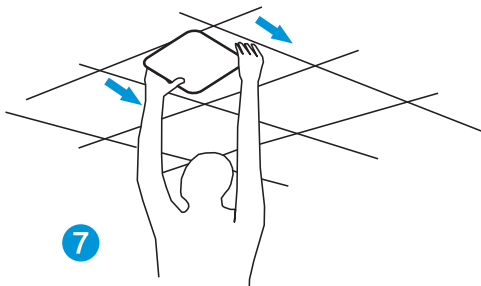
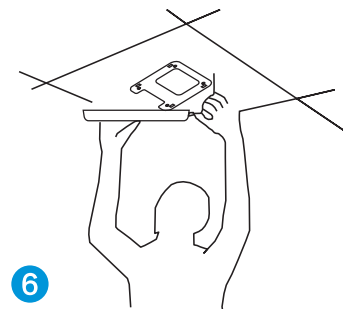
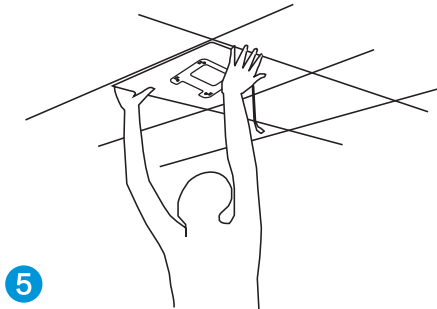
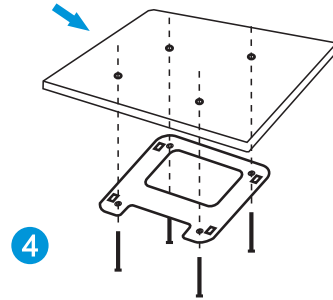
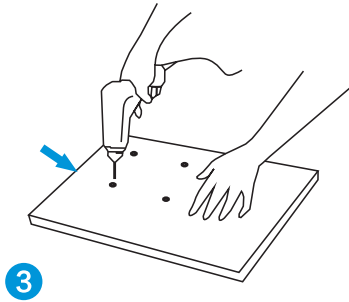
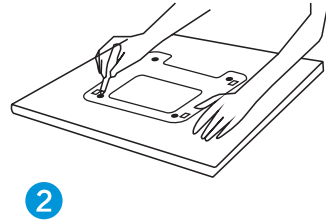
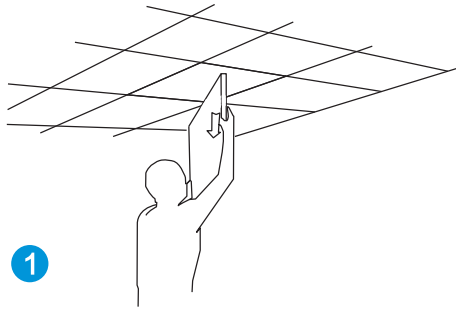

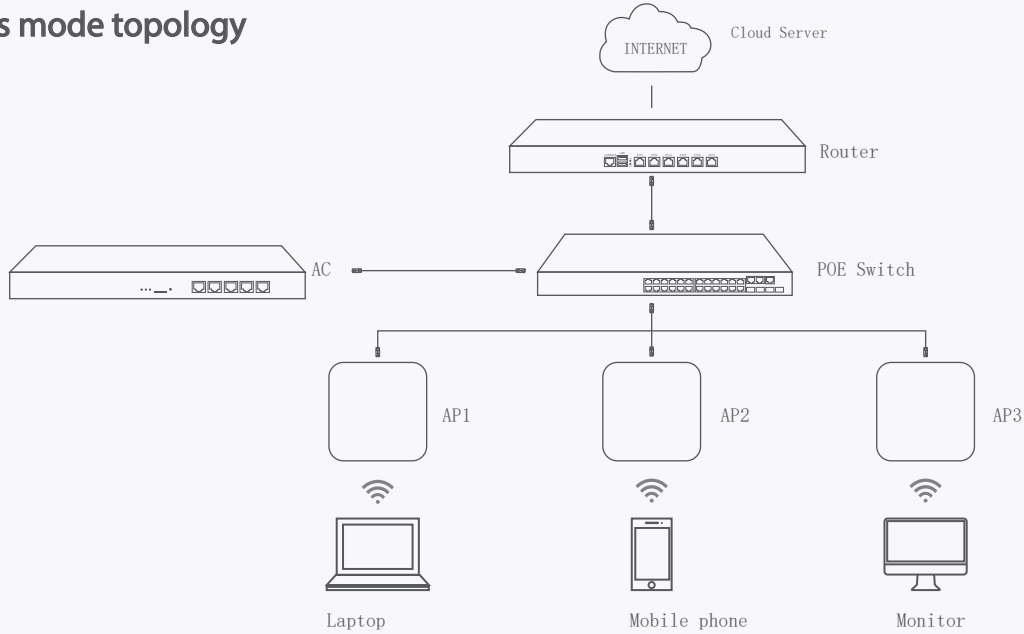

3/Device connection

Bypass mode topology

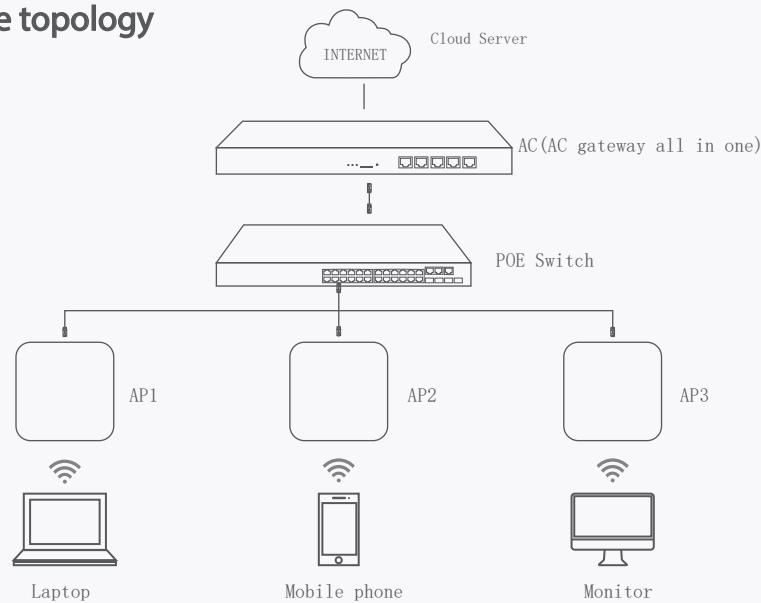

AC Gateway mode topology



 Tips: If the AP supports 24V POE, pls use 24V PoE switch or POE adapter; if the AP is a standard 48V POE device, please use a standard IEEE802.3at POE switch or POE adapter. When deploy a large wireless network, there are many APs in this network, it is recommended to use a wireless AC controller in the network to centralized-manage all APs in the network.

4/Device management

4.1 Management from WEB UI

Connect PC by wireless

(1) To connect an AP wirelessly, you need set the IP address of the TCP/IP properties of the wireless network card to 192.168.188.X (X is number range of 2-252) first, so that the AP and PC in the same IP segment, and set the subnet mask to 255.255.255.0, as shown in the following picture:

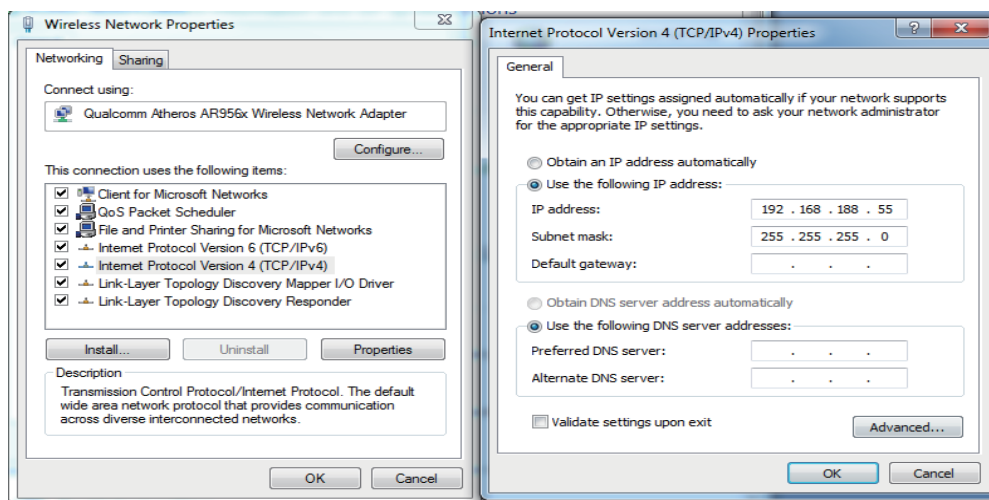

(2) After setting the IP address of PC, connect PC with AP in wireless, double-click "Wireless network Connection", in the pop-up wireless SSID list, select "XonTel_2G", click "Connect", then enter the password in the pop-up password dialogue box, the default password is "12345678", click "OK" to connect.



Connect PC by wired port

Using the wired connection, set the IP address of the TCP/IP properties of the wired network card to 192.168.188.X (X is number range of 2-252), and the PC will be the same IP segment as AP.

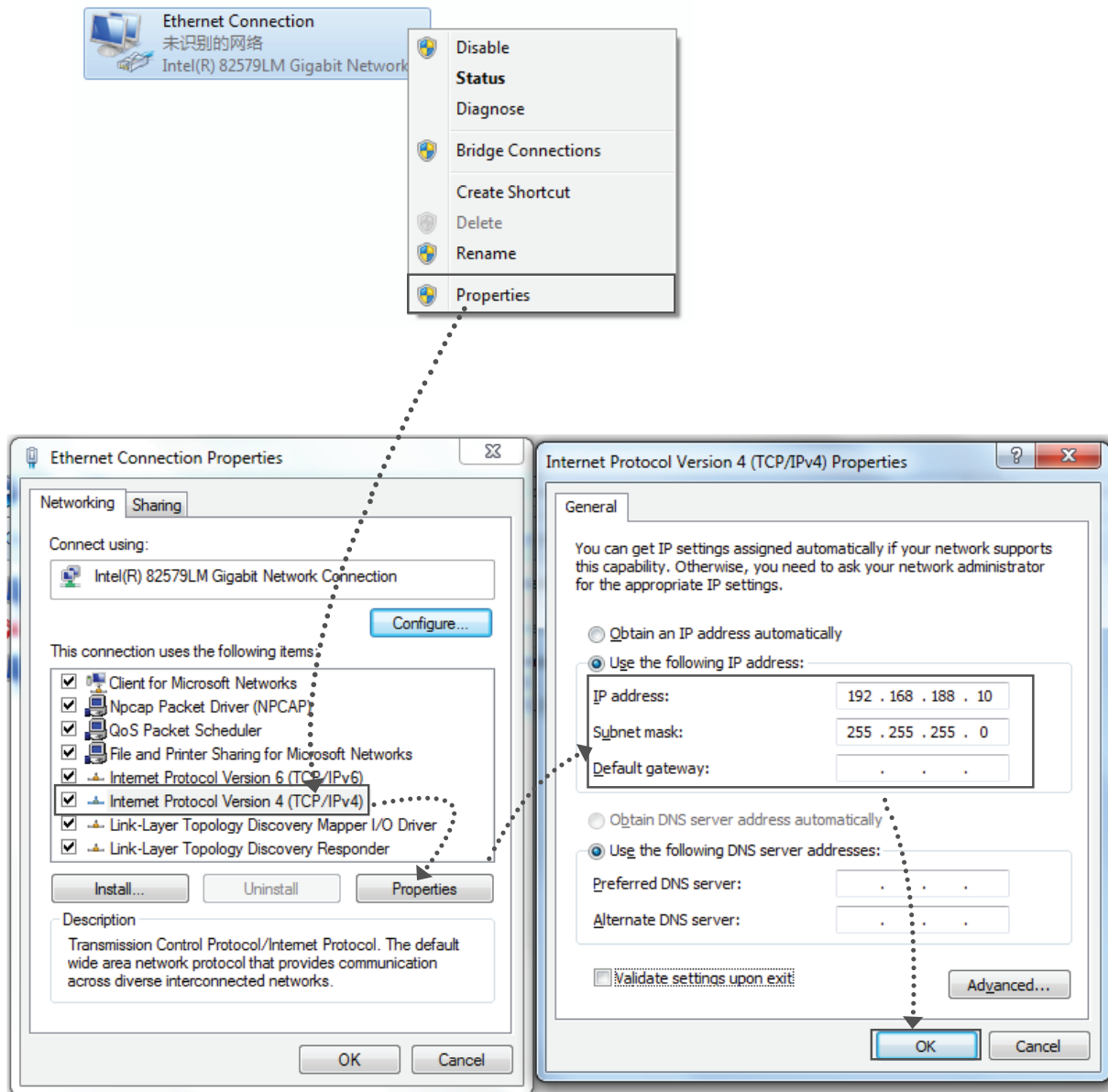

4.2 AP mode

1. Use Internet Explorer to visit <http://192.168.188.253>, pop up the login dialogue box shown in the following picture, input the default login password: xontel , then press "Login" to enter the wireless AP's management user interface page.

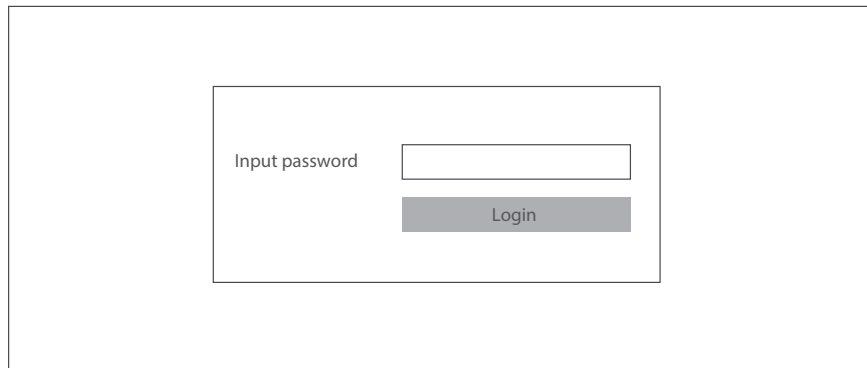

A login dialog box with a text input field labeled "Input password" and a "Login" button.

2. By default it is in Fit AP mode, users need click the button  at the right corner to change it to FAT AP mode if needed.

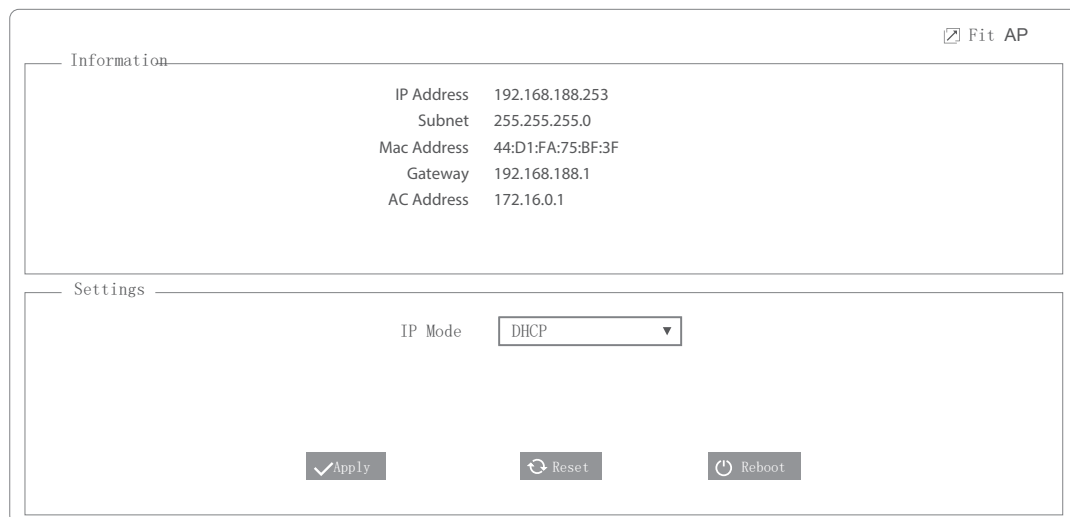

The AP management interface showing information and settings. The "Fit AP" mode is selected in the top right corner.

Information	
IP Address	192.168.188.253
Subnet	255.255.255.0
Mac Address	44:D1:FA:75:BF:3F
Gateway	192.168.188.1
AC Address	172.16.0.1

Settings

IP Mode:

3. In FAT AP mode user interface home page is as shown below:

Operation Mode AP Mode Fat AP

Flow (2G Wifi) bps

Uptime 01:05:39

Device Information	Device Description	LAN Information	WiFi Information
CPU Usage 1% Memory Usage 20%	Click Settings	IP Mode Get IP From AC Lan IP 192.168.188.253 Subnet 255.255.255.0 AC Address 172.16.0.1 MAC Address 44:D1:FA:75:BF:3F	Status ON <input type="checkbox"/> SSID XonTel_2G Channel 11 Encrypt Open MAC Address 44:D1:FA:75:BF:41

4. Setup Wizard page, choose AP mode as the current working mode.

Current Mode

Gateway Repeater Mode WISP Mode AP Mode

In this mode the AP wireless interface and cable interfac are bridging together. Without NAT, firewall and all network related functions.

5. Enter AP Mode setup page, choose "Get IP from AC" in connection type, click Next.

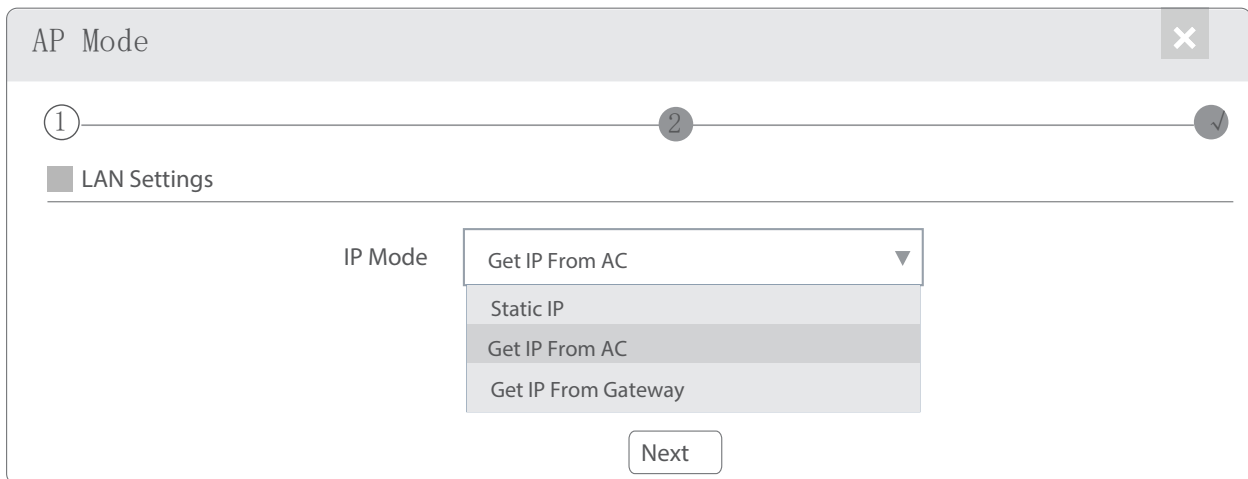

The screenshot shows the 'AP Mode' configuration window with a progress bar at the top. The second step is active. Under 'LAN Settings', the 'IP Mode' dropdown menu is open, showing options: 'Get IP From AC' (selected), 'Static IP', 'Get IP From AC', and 'Get IP From Gateway'. A 'Next' button is located at the bottom right.

6. Enter Wifi setup page, set up SSID, Channel, Encryption parameters as shown below:

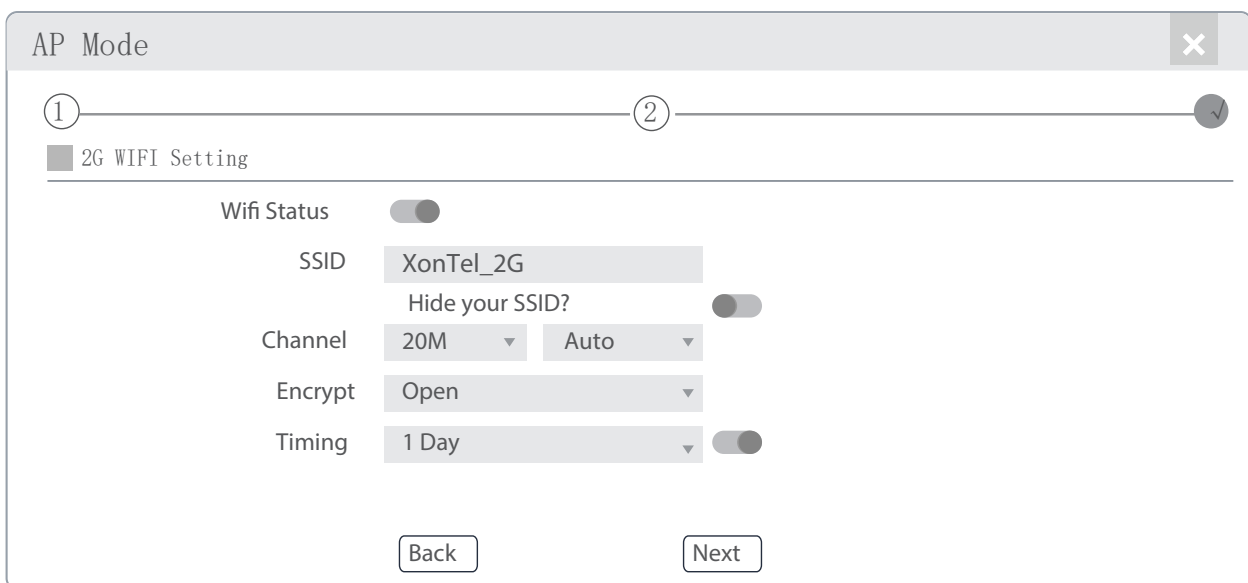

The screenshot shows the 'AP Mode' configuration window with a progress bar at the top. The second step is active. Under '2G WIFI Setting', the 'Wifi Status' toggle is turned on. The 'SSID' is 'XonTel_2G', and 'Hide your SSID?' is turned off. The 'Channel' is set to '20M' and 'Auto'. The 'Encrypt' dropdown is set to 'Open', and the 'Timing' dropdown is set to '1 Day'. 'Back' and 'Next' buttons are at the bottom.

7. Click Next and setup completed

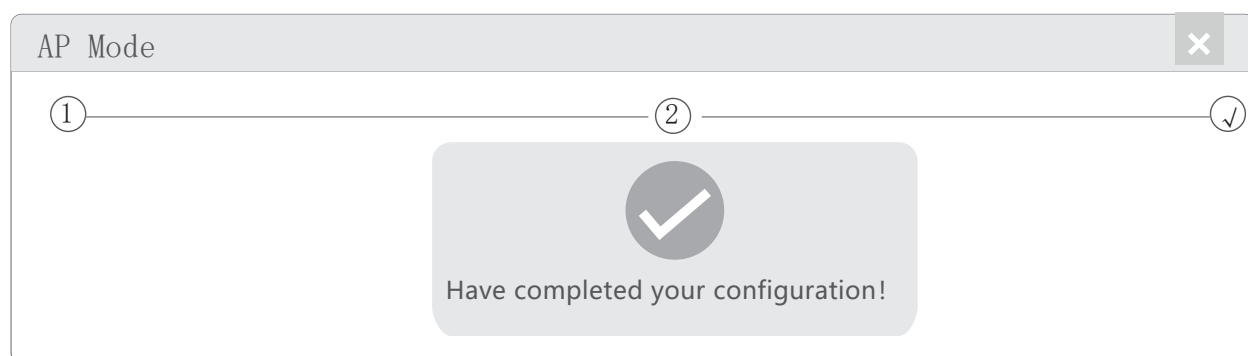

The screenshot shows the 'AP Mode' configuration window with a progress bar at the top. The second step is active. A large grey box with a checkmark icon and the text 'Have completed your configuration!' is centered on the screen.

4.3 Internet connection and status view

IP settings: After the configuration is completed, the wireless AP will restart and enter the Operation Mode you set. Then change the IP address of your computer to Obtain an IP address automatically, computer and other wireless devices can connect to the AP for Internet access.

View status: Manually set a fixed IP address for your computer to 192.168.188.X (X is number range of 2-252) , then login the wireless AP by its IP address to enter the management user interface and view it status, as shown in the following picture.



4.4 Device Management

Users can backup, reboot and reset to factory default settings through device management menu options. Also you can modify the WEB login password, upgrade firmware, time synchronization and system log statistics and other functional settings as shown in picture below.

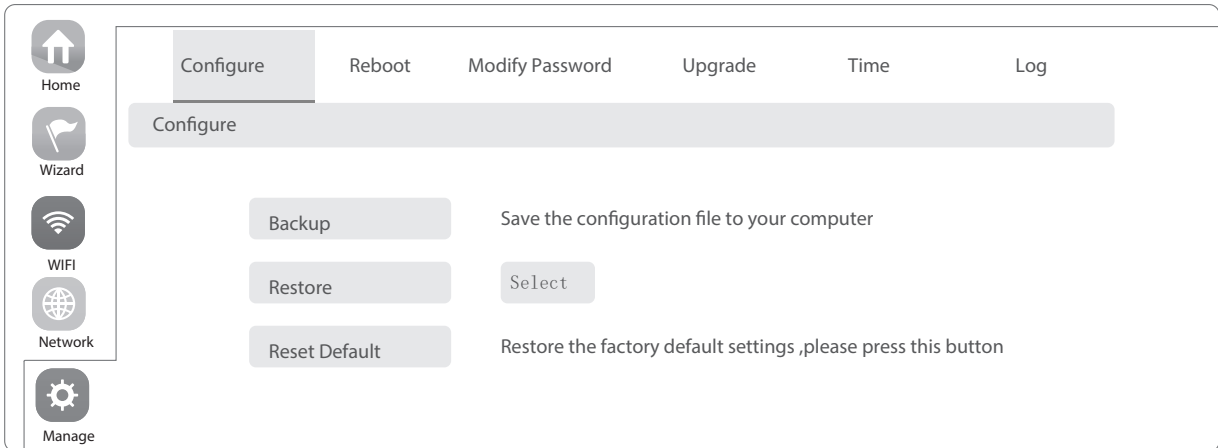

4.5 Wireless testing

1. Use Laptop or mobile phone to test whether the wireless network can surf the Internet: click wireless network , select the wireless SSID, enter the password to connect the wireless AP, test whether you can surf the Internet.
2. Check the status of the wireless network connection: signal quality, speed, Bytes sent and received. Click on Details, check if the IP address and DNS server address etc. obtained correctly, confirm that the device is working properly.

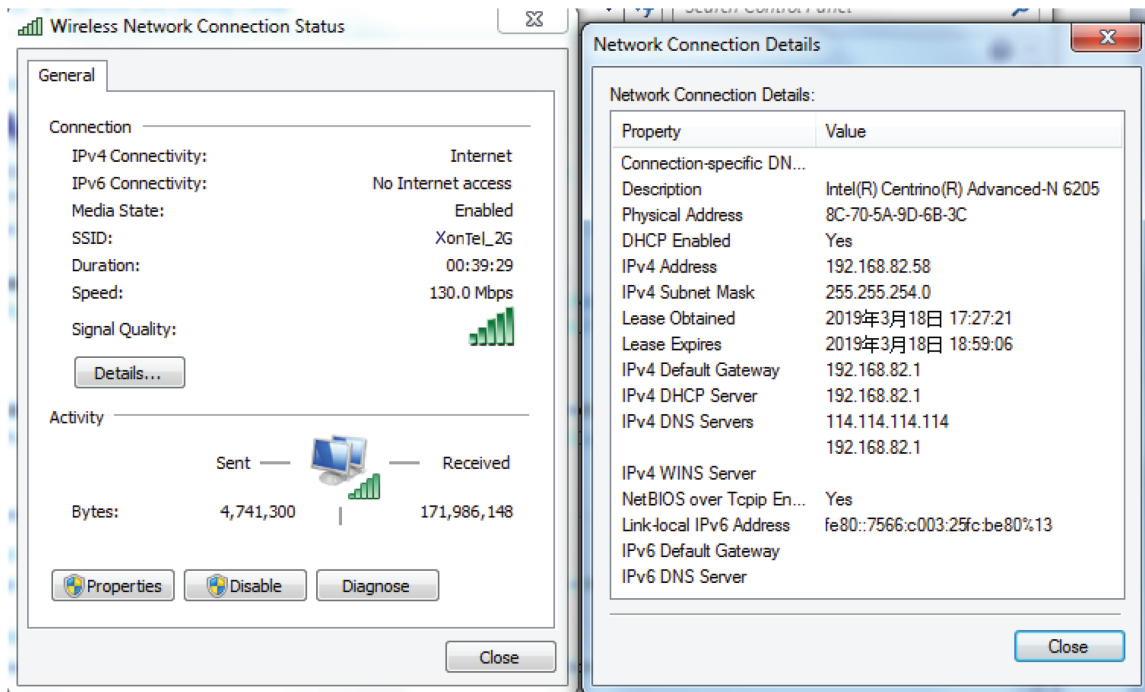

4.6 Other mode

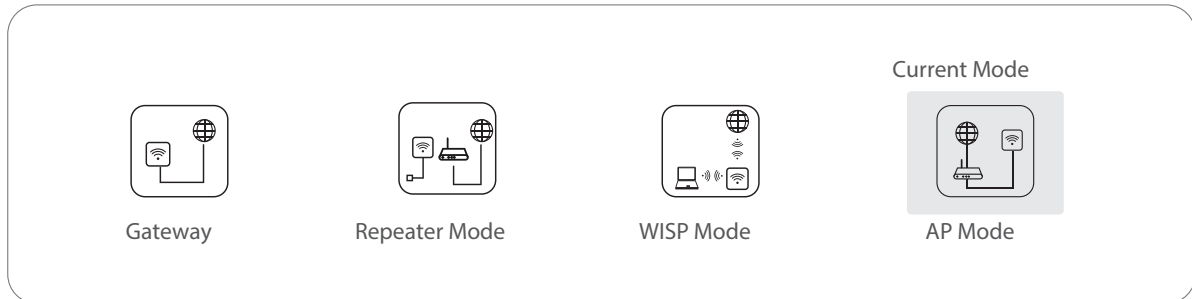

- Gateway Mode
Realize router function, WAN port connect with modem (ADSL or Fiber) , or WAN port connect internet by dynamic or static IP type.
- Repeater mode
Realize wireless bridge and forwarding without compatibility matching with the upper device.
- WISP Mode
Wireless ISP clients connect to the wireless base station by wireless, to realize local LAN internet connection sharing.
- AP mode
Under AP mode, NAT, DHCP, firewall, and all WAN related functions are turned off, all wireless and wired interfaces are bridged together, no distinguishing between LAN and WAN.

Operation mode setup

Based on the Quick Setup Wizard for each mode shown in the above picture, Set the parameters and options that user needs, and click Next step until the settings for each operation mode are completed .

5/Use mobile phone to login

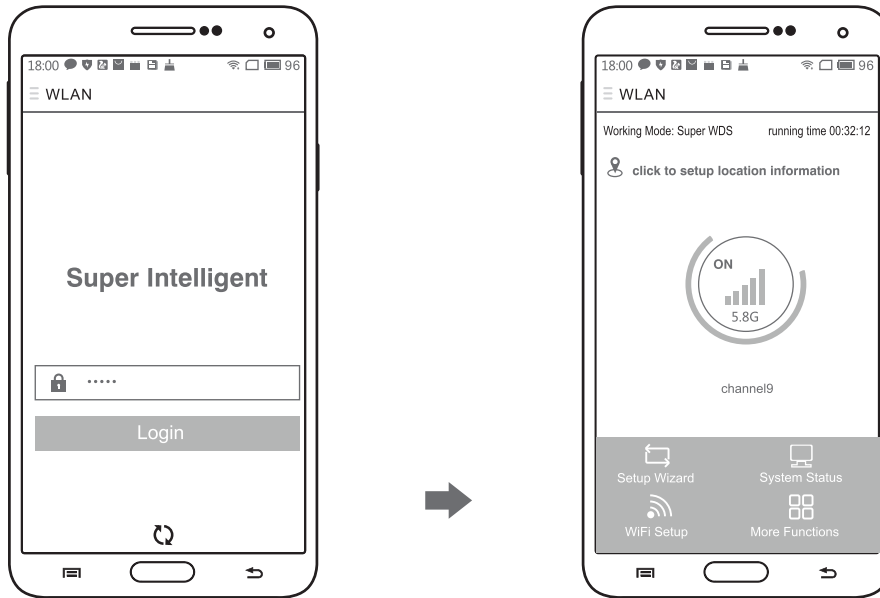

- When mobile phone connect to AP through wireless, need to configure static IP according to below steps

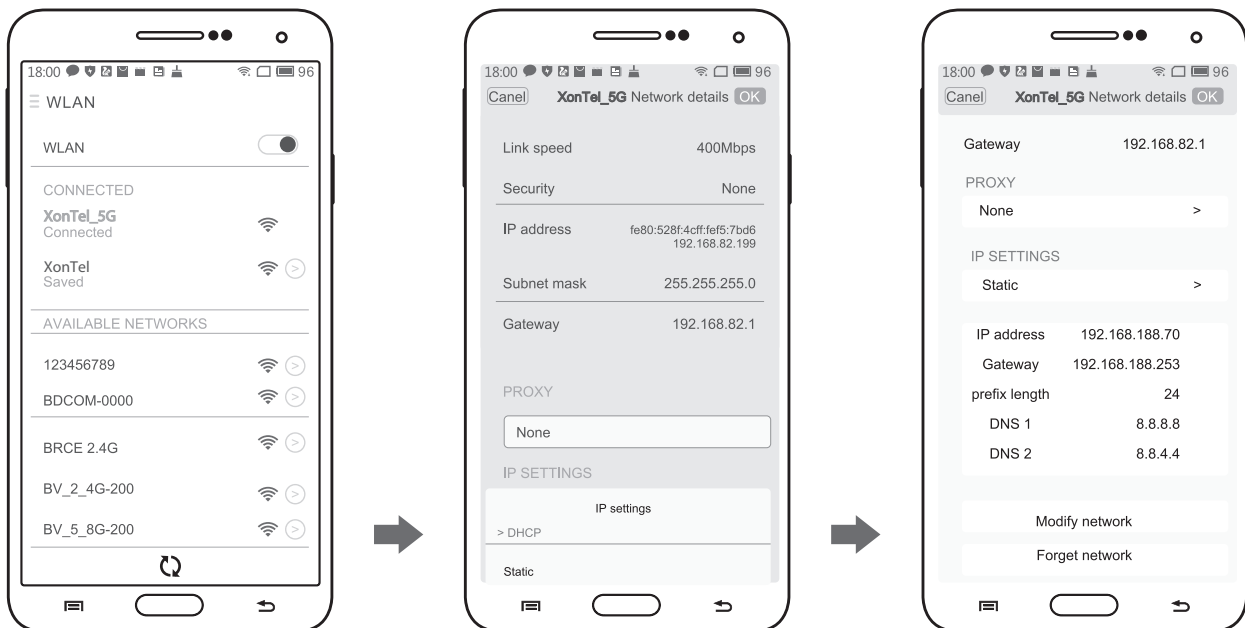

①. Android system setup steps

①. How to set static IP for Android system mobile phone

Open the phone click "settings", choose "WLAN", find and long press the SSID of the AP, pop-up menu select "Static IP", set a static IP 192.168.188.X (X can not be 253 or 252) (the static IP should be same IP segment as AP) for mobile phone, then input the right Gateway IP, network mask and DNS.

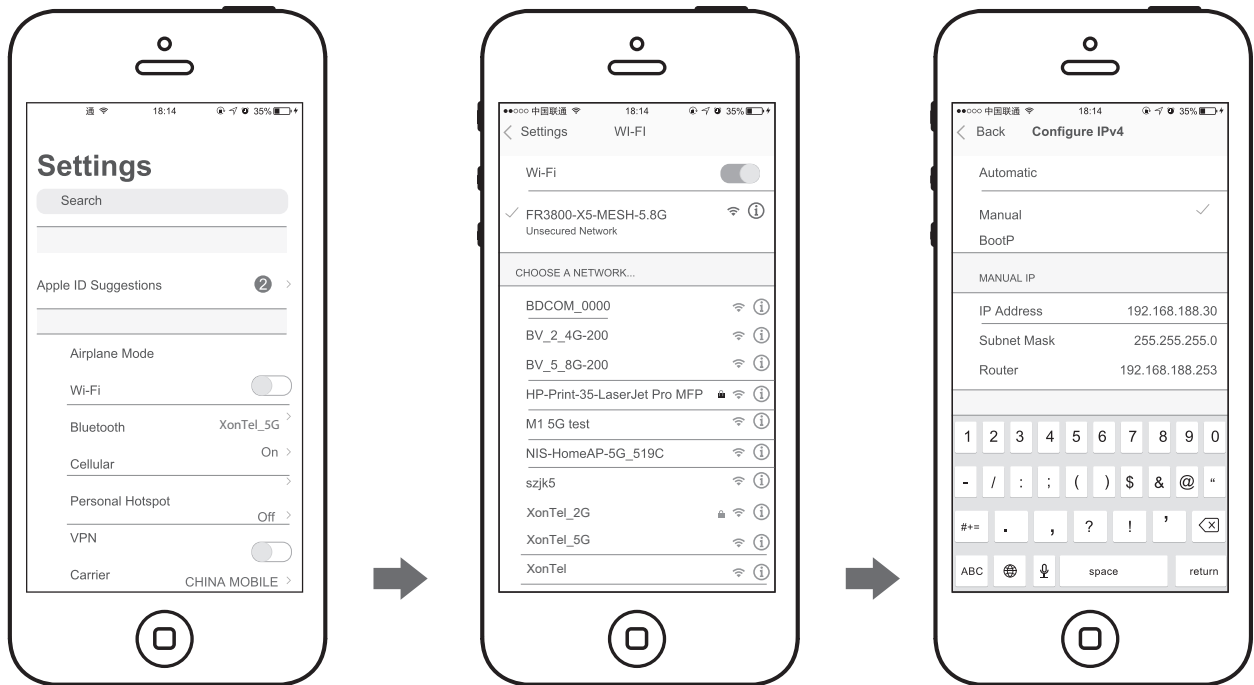

②. IOS system setup steps

②. How to set static IP for IOS system mobile phone

Click "settings", choose "Wi-Fi", click exclamation mark (i) after connect wireless signal successfully, setup the static IP 192.168.188.X (X can not be 253 or 252), then input gateway IP, subnet mask and DNS, please note: the static IP should be in the same IP segment as AP.

FAQ and Solutions

Q1: Forget login name and password ?

A1: Reset to factory default settings: press the reset button for above 10 seconds and release it , the device will reboot and reset to factory default settings automatically.

Q2: Can not Login wireless AP management WEB interface ?

A2: 1.Check if PC with static IP and if this IP is in the same IP segment of AP, make sure it is not set to other IP range.
2.Reset AP to factory default settings and re-connect to AP.
3.Make sure wireless AP IP address is 192.168.188.253 and not occupied by other devices .
4.Check if there is something wrong with PC and Ethernet cable ,recommend to use CAT 5e or above UTP cable .

Q3: Forget wireless network password ?

A3: 1.Connect AP by wired ,login WEB management interface ,click wireless settings---> basic settings--->Encryption--->Password, and set a new password for wireless network.
2.Reset AP to factory default settings, the default password is 12345678

Q4: Can not obtain IP Address ?

A4: 1.In gateway or WISP mode, check if DHCP server is enabled
2.In repeater or AP mode, check if upper network connection is normal ,or if LAN network DHCP server is working well .

Q5: How to change FIT AP to FAT AP ?

A5: Switch FAT and FIT mode by clicking the button  at right corner ,then device will reboot .After rebooting,please clear history buffer files in IE and then login .

NOTE: Once the device is switched to FAT AP mode , AC controller will not be able to manage and control it .

Q6: AC controller device list can not get AP devices ?

A6: The mode for AC controller and AP are different, AC controller with model prefixed AC is used to control FAT AP, the model prefixed in FAC or BW is used to control FIT AP .

NOTE: All the APs support both FAT and FIT AP mode , the default mode is FIT AP mode.

*This manual is only used for instructions and provides an accurate information as we can , but we can not make sure all the information in this manual is correct.This manual may be updated because of the products upgrade,we have the right to revise the manual without any notice.